

4M CMOS UV Camera

ID4MUVG2-CL2

Technical Manual

iDule Corporation

Table of Contents

	PAGE
1. Product Outline	3
2. Handling Precautions	3
3. Specification	4
3.1. General Specification.....	4
3.2. Camera Output Signal Specification	6
3.3. Spectral Response (Representative Value).....	7
4. Connector	9
4.1. Camera Link Connector 12226-1100-00PL (3M)	9
4.2. Power LED	10
4.3. 12 PIN Connector HR10A-10R-12PB(HIROSE) CN1.....	10
5. Timing Chart	10
5.1. Horizontal Synchronous Signals Timing (2Tap Base Configuration)	11
5.2. Vertical Synchronous Signals Timing (2Tap Base Configuration)	11
5.3. Video Output Format (2Tap).....	12
5.4. Camera Link output Bit Assignment (2Tap Base Configuration).....	12
5.5. Fixed Trigger Shutter Mode (Rolling Shutter)	13
5.10. Pulse Width Trigger Shutter Mode (Rolling Shutter)	14
5.7. Global Reset Mode.....	15
6. Partial Scan Mode	16
6.1. Partial Scan Mode Setting	16
6.2. Shutter time when partial scan mode is ON	18
7. Image Filter and Gamma Function	19
8. 2-CMOS Mode	23
9. Remote Communication	24
8.1. Command Specifications.....	25
8.2. Control Example	29
10. Function Setting	33
11. Dimensions	37
12. Initial Setting	38
13. Cases for Indemnity (Limited Warranty)	39
14. CMOS Pixel Defect	39
15. Product Support	39

1. Product Outline

ID4MUVG2-CL2 is a Camera Link interfaced and 4M resolution camera module. 4M pixels CMOS sensor with diagonal length 18.826mm is utilized. Entire pixels can be read out within 1/22s at Base Configuration output.

Features

- Rolling Shutter CMOS sensor is utilized.
- Camera Link Base , Medium Configuration are supported.
- Fixed trigger shutter mode, pulse width trigger shutter mode are operable.
- Full frame rates are as follows.

2Tap Base Configuration	22.648fps (Low/High Gain)	8/10/12bit
-------------------------	---------------------------	------------

2. Handling Precautions

The camera must not be used for any nuclear equipment or aerospace equipment with which mechanical failure or malfunction could result in serious bodily injury or loss of human life. Our warranty does not apply to damages or defects caused by irregular and /or abnormal use of the product.

Please observe all warnings and cautions stated below.

Our warranty does not apply to damages or malfunctions caused by neglecting these precautions.

Do not use or store the camera in the following extreme conditions :

- Extremely dusty or humid places.
 - Extremely hot or cold places (operating temperature -5°C to +45°C).
 - Close to generators of powerful electromagnetic radiation such as radio or TV transmitters.
 - Places subject to fluorescent light reflections.
 - Places subject to unstable (flickering, etc.) lighting conditions.
 - Places subject to strong vibration.
-
- Remove dust or dirt on the surface of the lens with a blower.
 - Do not apply excessive force or static electricity that could damage the camera.
 - Do not shoot direct images that are extremely bright (e.g., light source, sun, etc.), and when camera is not in use, put the lens cap on.
 - Confirm the mutual ground potential carefully and then connect the camera to monitors or computers. AC leaks from the connected devices may cause damages or destroy the camera.
 - Do not apply excessive voltage. (Use only the specified voltage.) Unstable or improper power supply voltage may cause damages or malfunction of the camera.
 - The voltage ripple of camera power DC +12V±10% shall be within ±50mV. Improper power supply voltage may cause noises on the video signals.
 - The rising time of camera power supply voltage shall be less than +10V, Max 60ms. Please avoid noises like chattering when rising.

3. Specification

3.1. General Specification

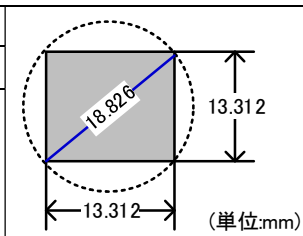
(1) Image Sensor	Type	Diagonal length 18.826mm, Rolling Shutter(Gpixel GSENSE2020BSI)		
	Effective Pixel Number	2048(H) x 2048(V)		
	Cell Size	6.5 μ m(H) x 6.5 μ m(V)		
	Image Circle	Φ 18.826mm		
				
(2) Video Output Frequency	Pixel Clock	52MHz		
	Output Effective Pixel number	2048(H) x 2048(V)		
	2Tap Base Configuration	22.648fps	560(H) x 2050(V) with Blanking	
(3) Video Output	2Tap Base Configuration			
(4) Output Format	Sensor AD	12bit		
	Camera Link	Low/High Gain	8/10/12 bit	
(5) Sensitivity	B/W	F11	2000lx (at shutter speed 1/22s, Gain 0dB)	
(6) Power Requirements	DC+12 \pm 10%			
(7) Power Consumption	typ 4.2W			

(8) Dimensions	H:55mm W:55mm D:45mm excluding projection	
(9) Weight	Approx. 190g	
(10) Lens Mount	M42 (P:1.0) Mount	
(11) Digital Gain Variable Range	x1.0(0dB) ~ x16.0(+24dB)	
(12) Analog Gain Variable Range	x1.0 ~ x13.5 (26step)	
(13) Shutter Speed Variable Range	2Tap Base Configuration	OFF(1/22s) ~ 1/130000s
(14) Trigger Shutter Mode	Fixed Trigger Shutter Mode, Pulse Width Shutter Trigger Mode	
(15) Partial Scan	1 Area Full Frame ~ 1Line (1Line/step)	
(16) Image Filter	3x3 filter, 3x3 median filter	
(17) Gamma	OFF($\gamma=1.0$), ON ($\gamma=0.45$)	
(18) CMOS Mode	Low Gain, High Gain, 2-CMS	
(19) Sensor of temperature	PCB around CMOS, PCB around FPGA (Not guaranteed accuracy)	
(20) Safety/Quality Standards	UL : Conform to UL Standard including materials and others.	
	CE : To be applied for EN55022:2006 Class B for Emission 06 To be applied for EN61000-6-2:2005 for Immunity	
	RoHS : Conform to RoHS	
(21) Durability	Vibration 20~200 Hz, 98m/s ² (10G), X,Y and Z directions (120 min for each direction)	
	Shock No malfunction shall be occurred with 980m/s ² (100G) for $\pm X, \pm Y, \pm Z$, 6 directions. (without package)	
(22) Operation Environment	Temperature -5 ~ +45°C Humidity 20 ~ 80%RH with no condensation.	
(23) Storage Environment	Temperature -25 ~ +60°C Humidity 20 ~ 80%RH with no condensation.	

3.2. Camera Output Signal Specification

(1)Video Output Data	Effective Video Output	2048(H) × 2048(V)	(at Full Frame Scan Mode)
(2)Sync Signal Output	LVAL FVAL DVAL	Camera Link Output	
(3)Camera Control Signal Input	CC2・CC3・CC4	Camera Link Input	No function
(4)Trigger Input	Polarity	Positive/Negative Selectable	(Address 05)
	Pulse Width	1HD(Min) ~ Approx.2 frames ・2Tap Base Configuration : 1HD (21.538us) Functionally, no upper limitation is set but noises such as dark noises and shadings might be noticeable at long time exposure.	
	12 pin Connector	12pin connector 11pin input (5V TTL)	(Trigger input)
	CC1	Camera Link	(Trigger input)
(5)GPIO Output	12 pin Connector	12pin Connector 6pin output (5V TTL)	(FVAL Output)
		12pin Connector 10pin output (5V TTL)	(Exposure Output)
(6)Serial Communication	SerTC (Serial to Camera)	Camera Link Input	
	SerTFG (Serial to Frame Grabber)	Camera Link Output	
(7)Video Signals	White Clip Level	FFh	(at Gain 0dB, 8bit)
	Setup Level	under 02h	
	Dark Shading	Both horizontal and vertical should be under 02Fh	

3.3. Spectral Response (Representative Value)

GSENSE 2020BSI

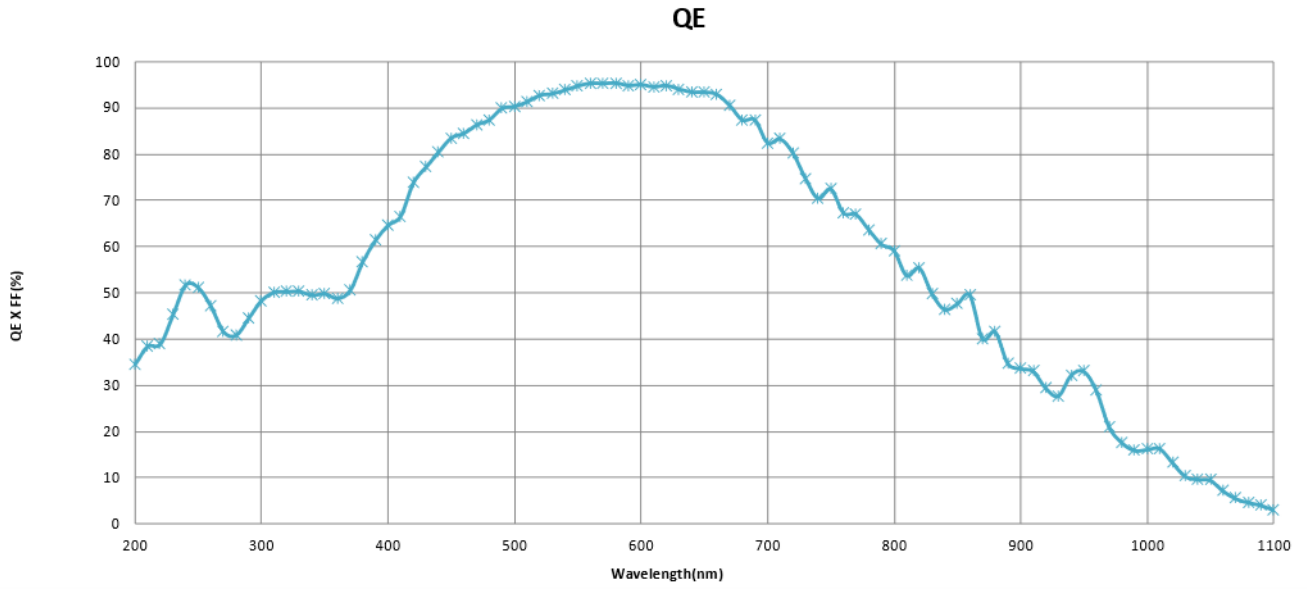

nm	QE
200	34.534
210	38.376
220	38.879
230	45.236
240	51.648
250	51.074
260	47.021
270	41.516
280	40.836
290	44.52
300	48.299
310	50.076
320	50.188
330	50.269
340	49.422
350	49.776
360	48.753
370	50.439
380	56.628
390	61.29
400	64.519
410	66.528
420	73.72407
430	77.12453
440	80.38589
450	83.44181
460	84.4337
470	86.24414
480	87.32163
490	89.82757
500	90.23738

nm	QE
510	91.25495
520	92.66307
530	92.98835
540	93.80048
550	94.65755
560	95.28609
570	95.21716
580	95.34128
590	94.78381
600	94.97534
610	94.49919
620	94.7806
630	94.00378
640	93.35536
650	93.35322
660	92.84925
670	90.49846
680	87.3334
690	87.3227
700	82.39428
710	83.21176
720	80.22218
730	74.684
740	70.347
750	72.425
760	67.25
770	66.907
780	63.606
790	60.473
800	59.06
810	53.658

nm	QE
820	55.353
830	49.781
840	46.359
850	47.555
860	49.413
870	40.024
880	41.561
890	34.648
900	33.569
910	32.989
920	29.356
930	27.67
940	32.119
950	33.004
960	28.824
970	21.018
980	17.609
990	15.89
1000	16.063
1010	16.29
1020	13.297
1030	10.341
1040	9.621
1050	9.444
1060	7.166
1070	5.481
1080	4.635
1090	4.047
1100	3.028

4. Connector

4.1. Camera Link Connector 12226-1100-00PL (3M)

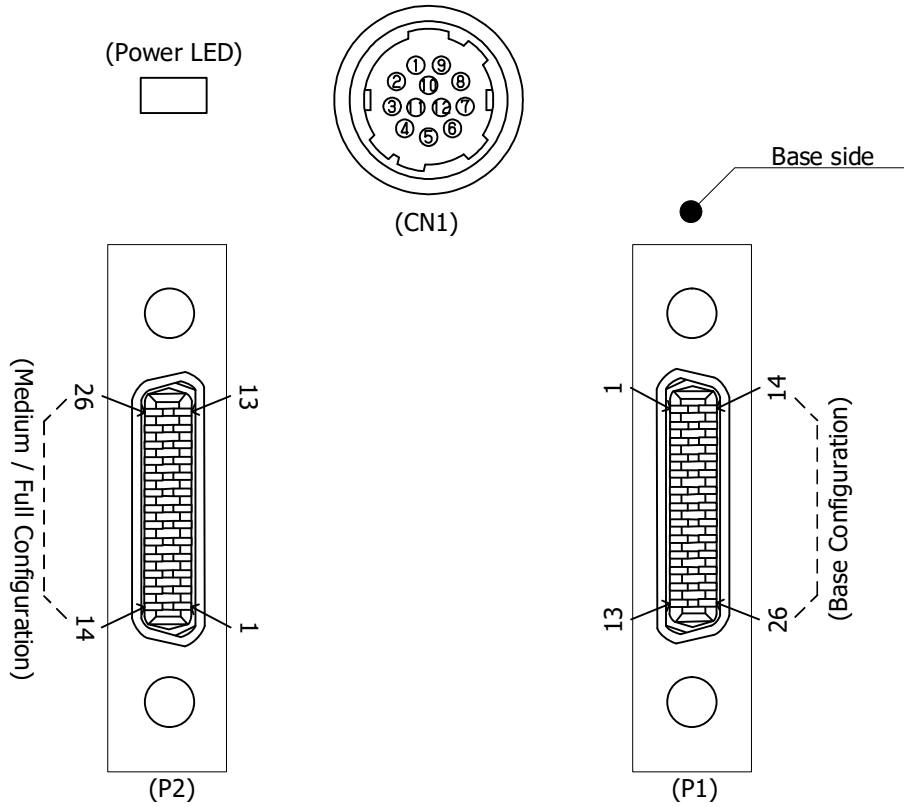

Connector (P2)

Pin No		Pin No	
1	+12V(PoCL)	14	GND
2	Y0-	15	Y0+
3	Y1-	16	Y1+
4	Y2-	17	Y2+
5	Yclk-	18	Yclk+
6	Y3-	19	Y3+
7	100Ω	20	Terminated
8	Z0-	21	Z0+
9	Z1-	22	Z1+
10	Z2-	23	Z2+
11	Zclk-	24	Zclk+
12	Z3-	25	Z3+
13	GND	26	+12V(PoCL)

Connector (P1)

Pin No		Pin No	
1	+12V(PoCL)	14	GND
2	X0-	15	X0+
3	X1-	16	X1+
4	X2-	17	X2+
5	Xclk-	18	Xclk+
6	X3-	19	X3+
7	SerTC+	20	SerTC-
8	SerTFG-	21	SerTFG+
9	CC1- (Trigger IN -)	22	CC1+ (Trigger IN +)
10	CC2+	23	CC2-
11	CC3-	24	CC3+
12	CC4+	25	CC4-
13	GND	26	+12V(PoCL)

4.2. Power LED

Camera turns on LED light, when it is supplied electricity from the frame Grabber board.

4.3. 12 PIN Connector HR10A-10R-12PB(HIROSE) CN1

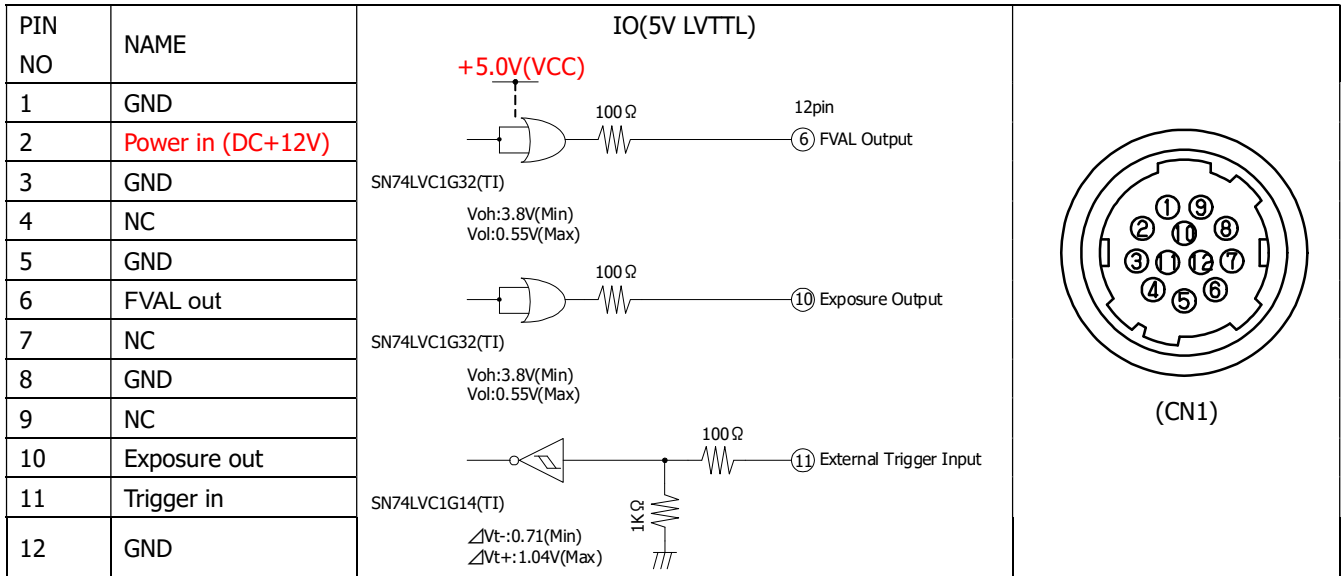

4.4. Power input Select

Power can be supplied from 12-pin connector (2pin) or Camera Link connector (PoCL).

(Since the power supply is diode OR connected, there is no problem even if power is supplied simultaneously.)

5. Timing Chart

5.1. Horizontal Synchronous Signals Timing (2Tap Base Configuration)

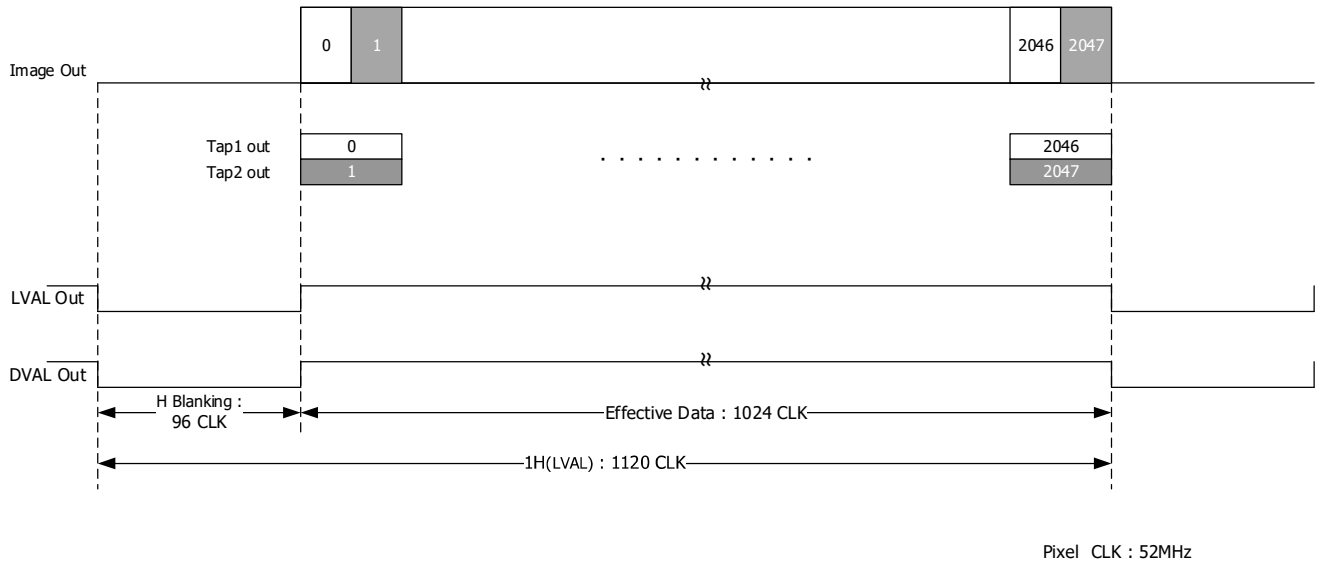

5.2. Vertical Synchronous Signals Timing (2Tap Base Configuration)

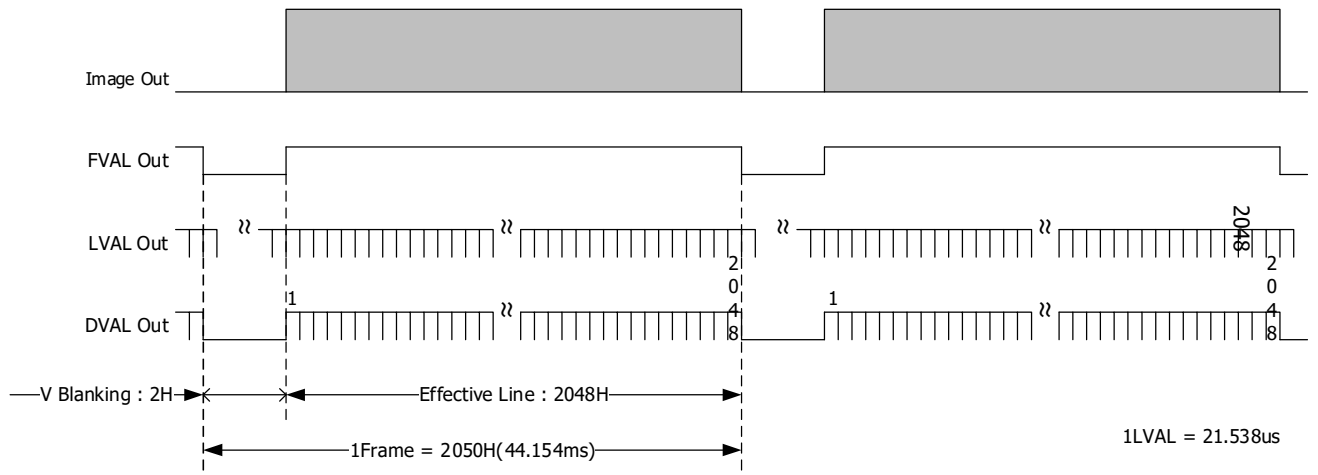

5.3. Video Output Format (2Tap)

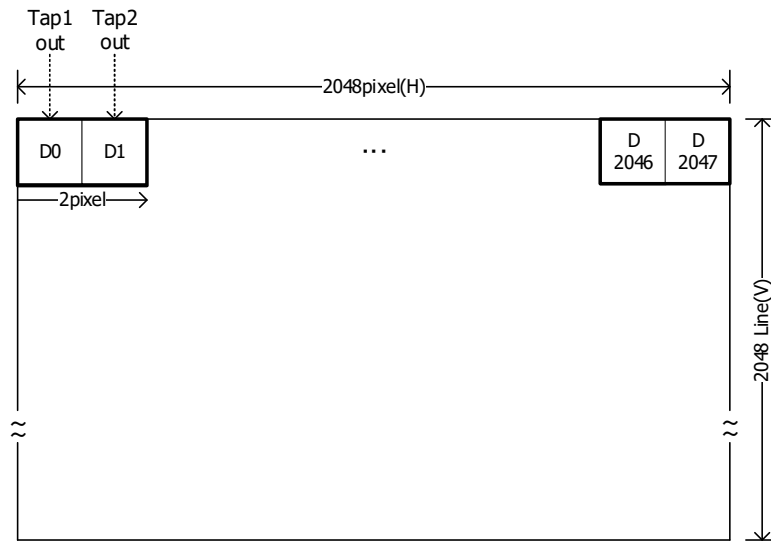

5.4. Camera Link output Bit Assignment (2Tap Base Configuration)

【8bit 出力】

Tap1		Tap2	
Port A0	D0	Port B0	D0
Port A1	D1	Port B1	D1
Port A2	D2	Port B2	D2
Port A3	D3	Port B3	D3
Port A4	D4	Port B4	D4
Port A5	D5	Port B5	D5
Port A6	D6	Port B6	D6
Port A7	D7	Port B7	D7

【10bit 出力】

Tap1		Tap2	
Port A0	D0	Port C0	D0
Port A1	D1	Port C1	D1
Port A2	D2	Port C2	D2
Port A3	D3	Port C3	D3
Port A4	D4	Port C4	D4
Port A5	D5	Port C5	D5
Port A6	D6	Port C6	D6
Port A7	D7	Port C7	D7
Port B0	D8	Port B4	D8
Port B1	D9	Port B5	D9

【12bit 出力】

Tap1		Tap2	
Port A0	D0	Port C0	D0
Port A1	D1	Port C1	D1
Port A2	D2	Port C2	D2
Port A3	D3	Port C3	D3
Port A4	D4	Port C4	D4
Port A5	D5	Port C5	D5
Port A6	D6	Port C6	D6
Port A7	D7	Port C7	D7
Port B0	D8	Port B4	D8
Port B1	D9	Port B5	D9
Port B2	D10	Port B6	D10
Port B3	D11	Port B7	D11

5.5. Fixed Trigger Shutter Mode (Rolling Shutter)

This is the mode to start exposure with external input trigger signals, and set the exposure time with serial commands. Triggers can be accepted even when outputting video signals.

However, trigger signals for exposure to start the next video output prior to the completion of video transmission for the prior video output signals can not be accepted.

Trigger input during exposure time should be ignored (A).

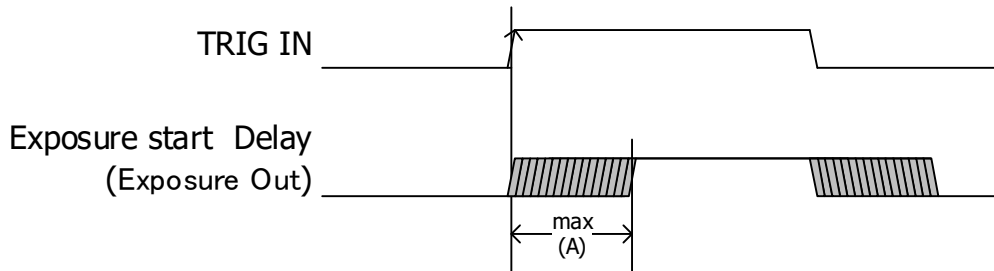

Exposure Start Delay : Base Configuration 2Tap (A) max 21.538us

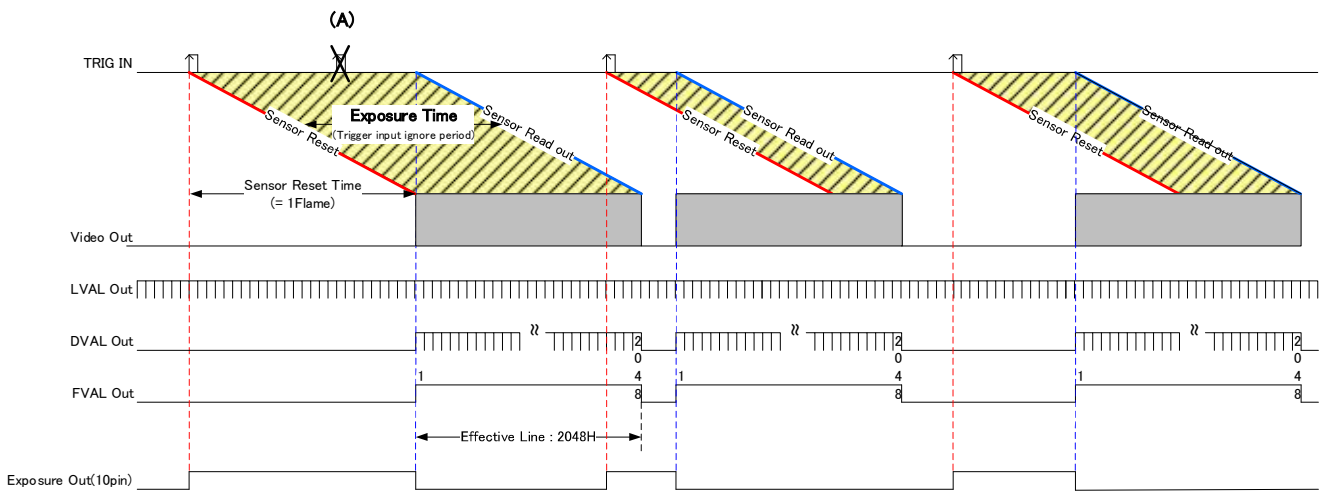

The exposure start time has a time difference of about 1 frame between the upper and lower lines of the image when all pixels are output. (Sensor Reset Time)

5.10. Pulse Width Trigger Shutter Mode (Rolling Shutter)

- This is the mode to start exposure with external input trigger signals, and set the exposure time with pulse width of the trigger signals.
- Pulse width is min. 1HD (min) to approx. 2 frames.
Functionally, there is no upper limitation, but noises such as dark noises and shadings may be noticeable at long time exposure.
- Triggers can be accepted even when outputting video signals.
However, trigger signals for exposure to start the next video output prior to the completion of video transmission for the prior video output signals can not be accepted (B).

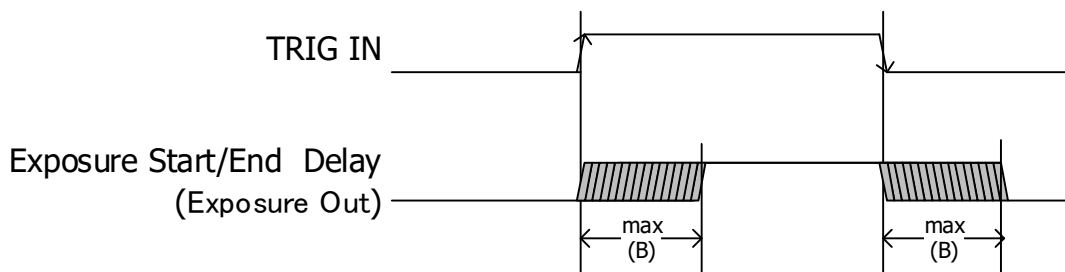

Exposure Start Delay : Base Configuration 2Tap (B) max 21.538us

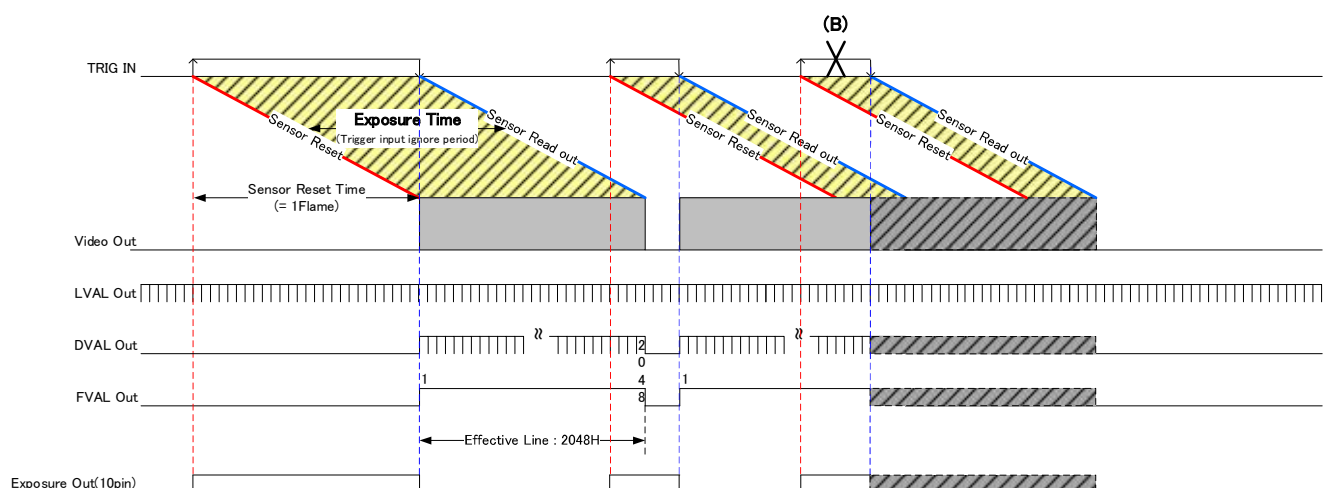

The exposure start time has a time difference of about 1 frame between the upper and lower lines of the image when all pixels are output. (Sensor Reset Time)

5.7. Global Reset Mode

When global reset mode is set to ON, the entire sensor pixel array is reset by externally input trigger signal, and exposure starts at the same time.

Global reset mode only works in trigger mode (address 04h = 01h or 02h).
With the above settings, it operates with global reset OFF.

Global reset mode does not work in 2-CMS mode (address 1Ch = 02h).
With the above settings, it operates with global reset OFF.

During the global reset mode operation, the next exposure is not started during image output from the sensor.
Please input the next trigger (exposure start) after image output is completed. (Lower figure (C))

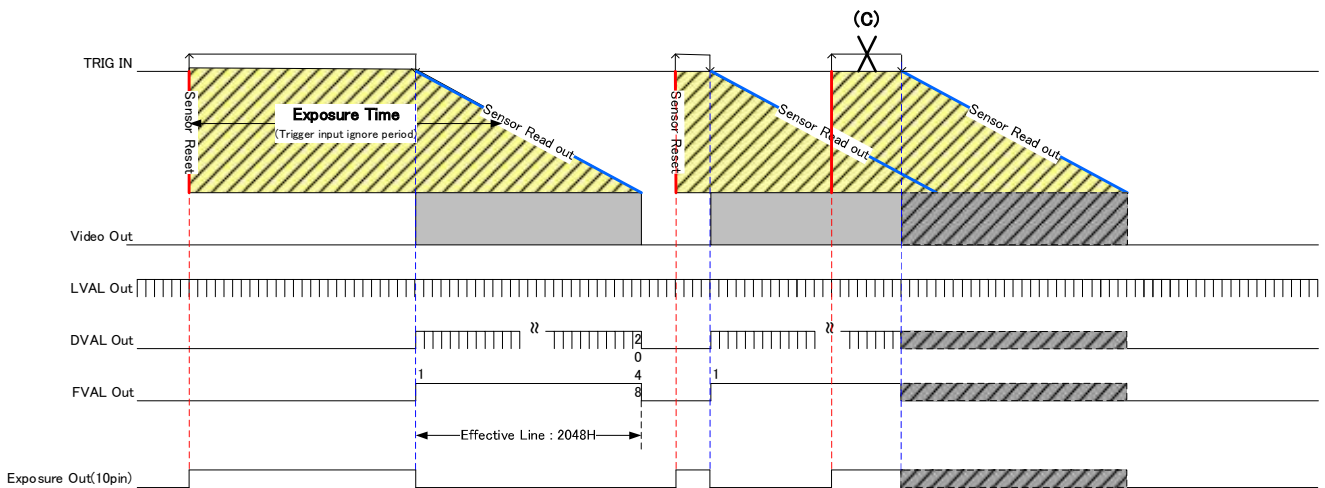

6. Partial Scan Mode

6.1. Partial Scan Mode Setting

1 partial area can be set by serial commands.

Example : 1 partial area to be set.

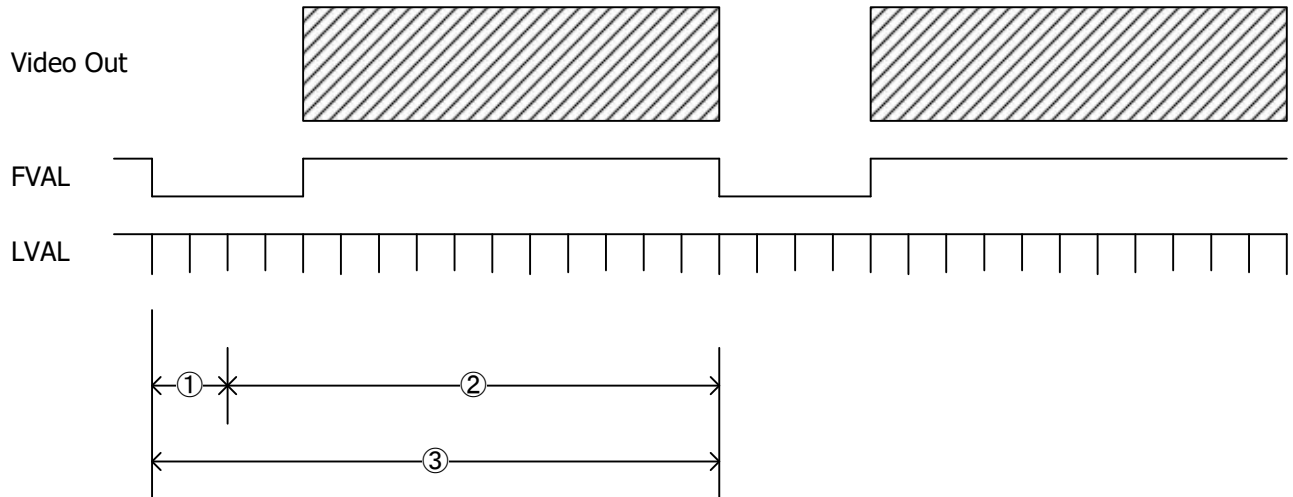

- ① : 2H fixed
 - ② : Partial Area : 20H
 - ③ : Total Frame line numbers : 22H(①+②)
-
-

Entire frame line numbers = **V blanking line numbers (2H fixed)** + Partial effective lines

Note that "Sum total of partial effective line numbers (except V blanking lines) < **2048**" should be met.

Frame rate = $1 / (\text{Entire frame line numbers} \times \text{Time for 1 line})$

Camera Mode	Time for 1 Line
2Tap Base Configuration	21.648us

Example

	Effective lines	Frame Total lines	Frame rate (fps)
			Base Configuration 2Tap
1(: min)	1H	3H	15476.5
.	.	.	.
Vertical :VGA	480H	482H	96.3
.	.	.	.
Vertical :XGA	768H	770H	60.3
.	.	.	.
Vertical :SXGA	1024H	1026H	45.3
.	.	.	.
Vertical :UXGA	1200H	1202H	38.6
.	.	.	.
2048 (max:Full frame)	2048H	2050H	22.6

6.2. Shutter time when partial scan mode is ON

Function	Address (Hex)	Data(Hex)	
Partial scan : Long exposure mode ON/OFF	1E	00:	OFF 【default】
		01:	ON

The shutter time when the partial scan mode is ON is clipped by the number of effective lines.

For example, with 1/2 partial scan (1024 effective lines) and 4 Tap Medium output, the shutter time is 22ms (shutter off). Even if is set, the shutter time will be 11ms because it will be clipped in the number of effective lines (11ms).

- (1) When the trigger is OFF (live operation): The frame rate is the number of partial effective lines + V blanking.
- (2) In fixed trigger shutter mode: The frame rate is the external trigger cycle.

If you want to operate with the set shutter time with the partial scan mode ON, set the address: 1Eh and the data: 01h.

- (1) When the trigger is OFF (live operation): The frame rate is fixed when the partial scan mode is OFF.
- (2) In fixed trigger shutter mode: The frame rate is the external trigger cycle.

In pulse width trigger shutter mode:

Since the pulse width is the shutter (exposure) time, the setting of address: 1Eh has no meaning (it is ignored).

7. Image Filter and Gamma Function

(1) A 3x3 filter or a 3x3 median filter can be set as the noise reduction filter.

Function	Address(Hex)	Data(Hex)	
Image Filter ON/OFF	1F	00:	OFF
		01:	3x3 Filter ON(Address: 60h~68h)
		02:	3x3 Median filter ON
		03:	3x3 Median filter ON + 3x3 filter ON

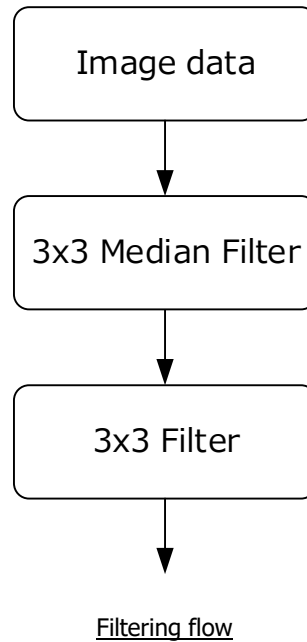

□ 3x3 Filter (Set to Total '1')

$$K = 1/16 \begin{pmatrix} (x0, Y0), & (x1, Y0), & (x2, Y0) \\ (x0, Y1), & (x1, Y1), & (x2, Y1) \\ (x0, Y2), & (x1, Y2), & (x2, Y2) \end{pmatrix}$$

$$K = 1/16 \begin{pmatrix} \text{Address } 60\text{h}, & \text{Address } 61\text{h}, & \text{Address } 62\text{h} \\ \text{Address } 63\text{h}, & \text{Address } 64\text{h}, & \text{Address } 65\text{h} \\ \text{Address } 66\text{h}, & \text{Address } 67\text{h}, & \text{Address } 68\text{h} \end{pmatrix}$$

Gaussian filter 【Factory default】

$$K = 1/16 \begin{pmatrix} 1 & 2 & 1 \\ 2 & 4 & 2 \\ 1 & 2 & 1 \end{pmatrix}$$

The coefficients that can be set are 1, 2, 4, 8.(Address: 60h~68h)

Image filter OFF (Address: 1Fh Data: 00h)

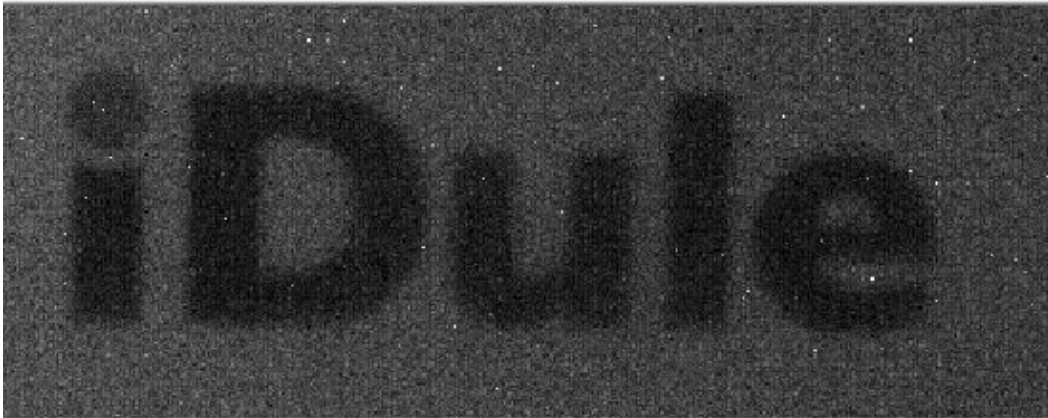

Image filter ON (Address: 1Fh Data: 01h) 3x3 filter

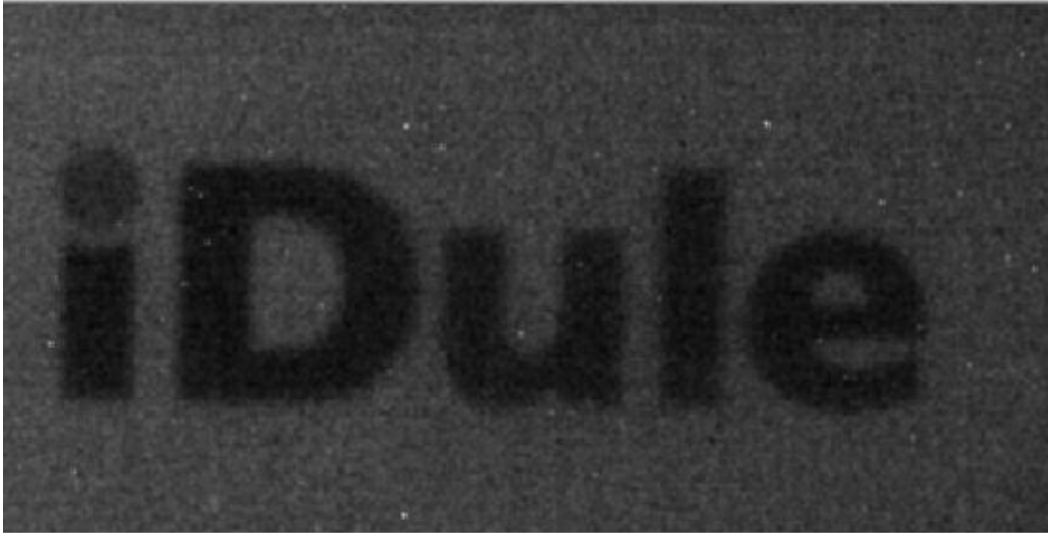
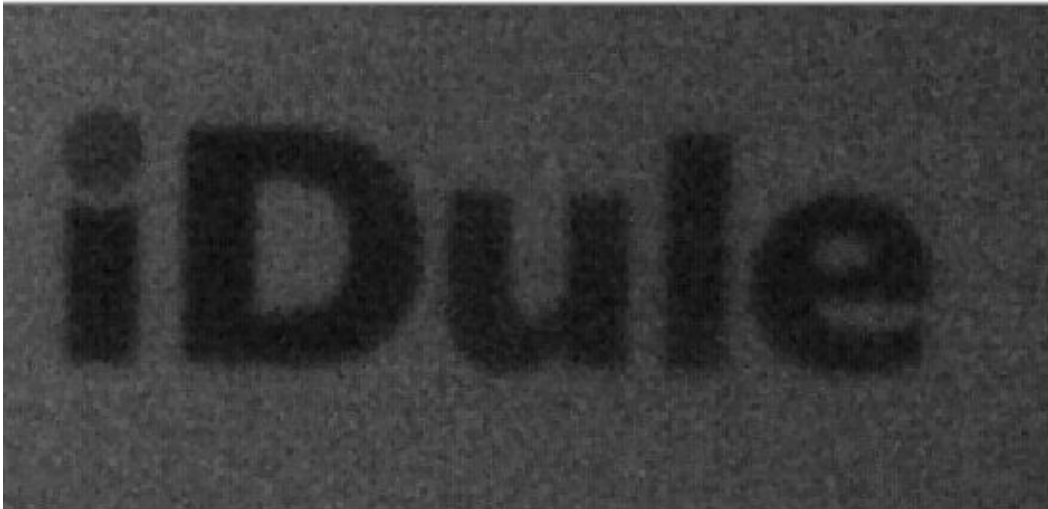
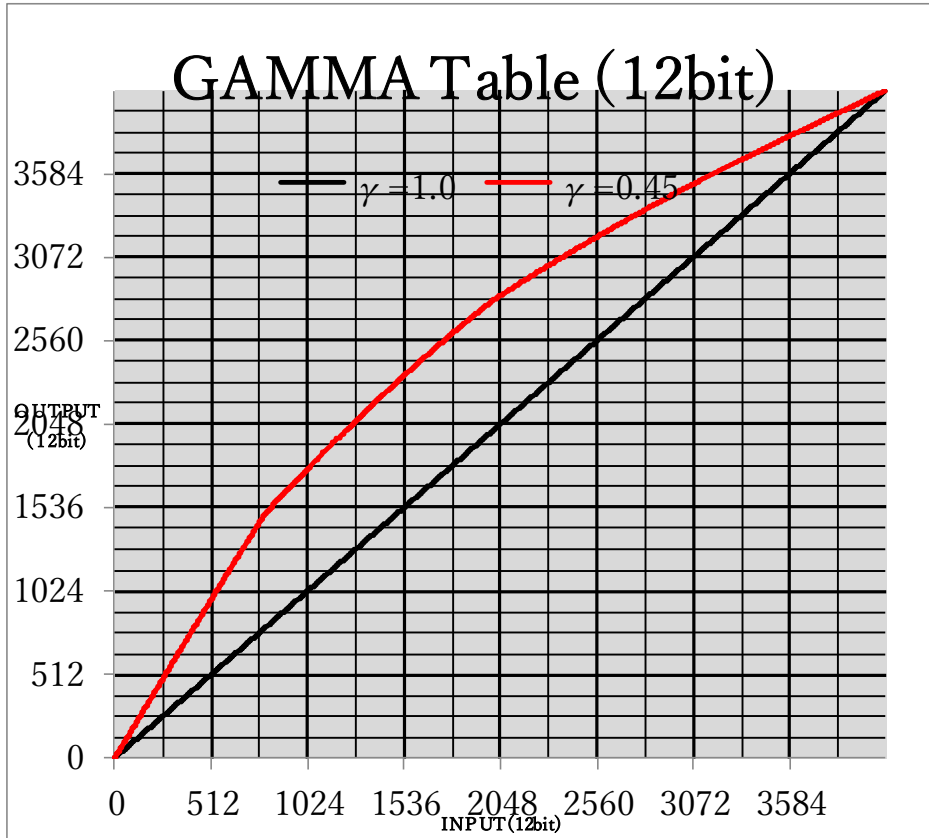

Image filter ON (Address: 1Fh Data: 02h) Median filter



(2) Gamma

Function	Address(Hex)	Data(Hex)	
Gamma ON/OFF	09	00:	Gamma OFF($\gamma=1.0$) 【Factory default】
		01:	Gamma ON ($\gamma=0.45$)



Gamma OFF ($\gamma = 1.0$) (Address: 09h Data: 00h)

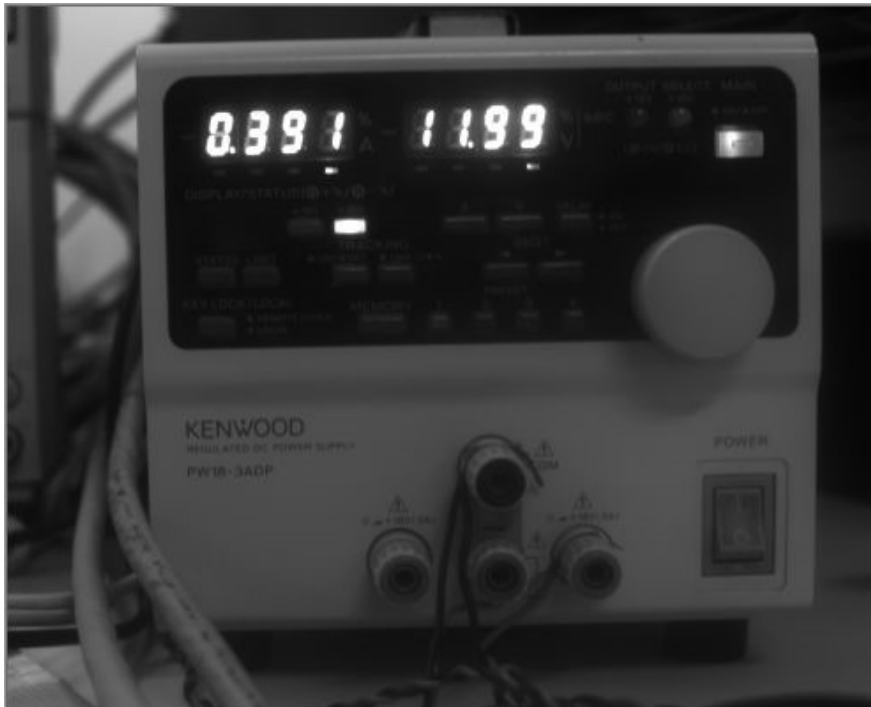

Gamma ON ($\gamma = 0.45$) (Address: 09h Data: 01h)



8. 2-CMOS Mode

It supports two correlated multiplex sampling (2-CMS) readout capabilities to reduce the sensor's transient read noise at the expense of dynamic range.

Correlated multiple sampling (CMS) can be used in applications that require very low read noise. With 2-CMS, you can reduce the reading noise from $1.6e^-$ to $1.2e^-$.

Function	Address(Hex)	Data(Hex)	
Mode	001C	00:	Low Gain mode
		01:	High Gain mode
		02:	2-CMS mode

□ Remarks:

- 2-CMS mode in global reset mode is not supported.

The figure below shows the structure of a 2-CMS image.

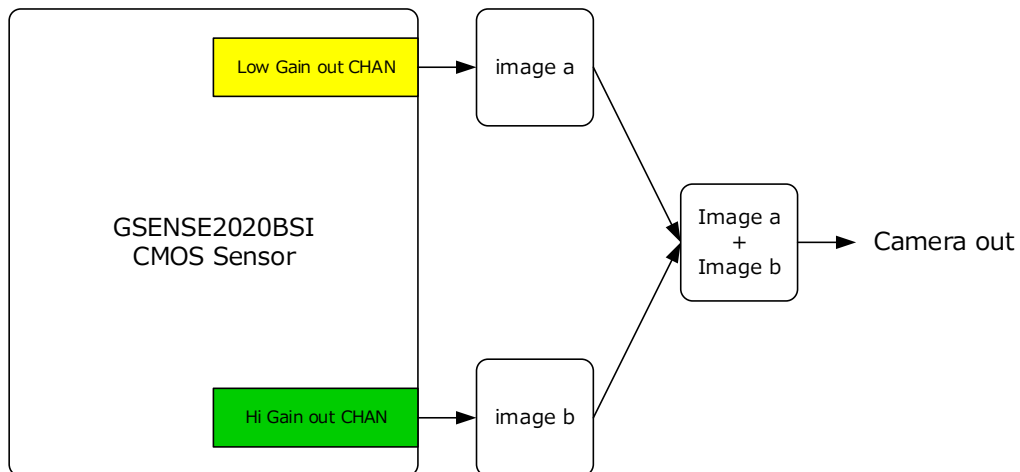

9. Remote Communication

Via camera link cable, the camera can be controlled.

Communication Settings	
Baud Rate	: 115200bps (Fixed)
Data	: 8bit
Stop bit	: 1bit
Parity	: None
XON / XOFF	: No Control

- Send Command Format (Host to Camera)

If send a command, set the command and parameter between STX and ETX.

STX (02H)	command (2byte)	parameter (ASCII code) (20H-7FH)	ETX (03H)
--------------	--------------------	-------------------------------------	--------------

- Return Command Format (Camera to Host)

Normally, a camera returns a control code which is ACK or NAK.

If return value has a text message, the message is between STX and ETX.

ACK (06H)	... Succeed
--------------	-------------

NAK (15H)	... Fail
--------------	----------

STX (02H)	command (2byte)	parameter (ASCII code) (2FH- 7FH)	ETX (03H)	... return message
--------------	--------------------	--------------------------------------	--------------	--------------------

- Command List

Command	Function
SR	Set some values of resister
GR	Get some values of resister
SU	Set a user's data
GU	Get a user's data
CS	Save all configurations
CR	Restore all configurations
QM	Get a model name
QS	Get a serial number
QV	Get a firmware version
QE	Get a detail of error information

8.1. Command Specifications

- 1) Set some values of register

【Command】 Set : Resister

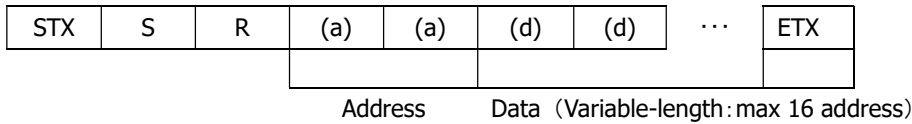

【Return Value】

Succeed	...	ACK
Fail	...	NAK

- 2) Get some value of register

【Command】 Get : Resister

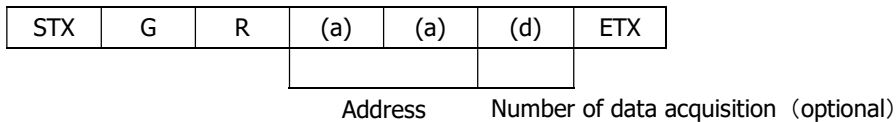

【Return value】

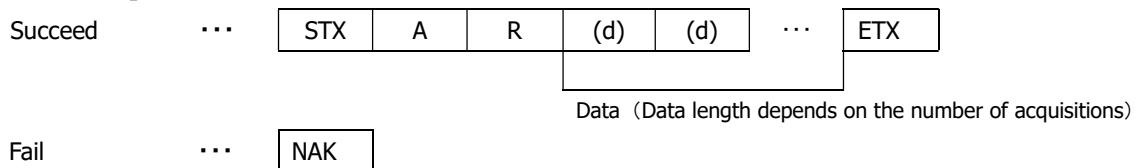

【Remarks】

The command gets some value of register of the specified address. The number of the acquisition is between '0' and 'F' (Hexadecimal).
 If appoint '0' at the address, the command send data of 16 address. If the command is omitted at the address, the command send an address.

5) Save all configurations

【Command】 Configuration : Save

STX	C	S	ETX
-----	---	---	-----

【Return Value】

Succeed	...	ACK
Fail	...	NAK

6) Restore all configurations

【Command】 Configuration : Restore

STX	C	R	ETX
-----	---	---	-----

【Return Value】

Succeed	...	ACK
Fail	...	NAK

7) Get a model name

【Command】 Query : Model name

STX	Q	M	ETX
-----	---	---	-----

【Return Value】

Succeed	...	STX	R	M	(d)	(d)	...	ETX
					Model name (Fixed length: 16byte)			
Fail	...	NAK						

8) Get a serial number

【Command】 Query : Serial number

STX	Q	S	ETX
-----	---	---	-----

【Return Value】

Succeed	...	STX	R	S	(d)	(d)	...	ETX
					Serial Number(Fixed length: 8byte)			
Fail	...	NAK						

9) Get a firmware version

【Command】 Query : Version

STX	Q	V	ETX
-----	---	---	-----

【Return Value】

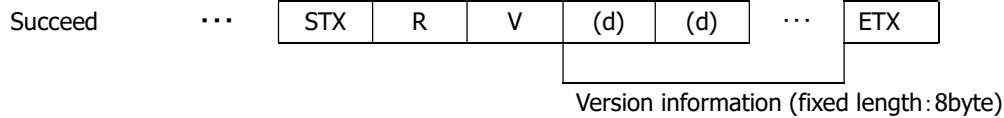

10) Get a detail of error information

【Command】 Query : Error

STX	Q	E	ETX
-----	---	---	-----

【Return Value】

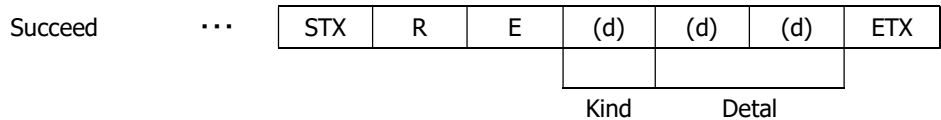

Kind	Detail
0: No Error	00: Normal result
1: Communication Protocol Error	00: The command is undefined.
	01: The command length is more than defined.
	02: The address is undefined.
	03: The value of data is undefined.
	04: The length is more than defined.
	05: The table number is undefined.
	06: The string of user data was abnormal.
2: Internal Control Error	00: Internal control is abnormal.
	01: A read only address was written by the command.
	02: A protected address was written by the command.
	03: Out of range address was written by the command.
	04: The selected table number is abnormal.
	05: The value of the man acquisition area is abnormal.
	06: A function is not implemented.

8.2. Control Example

1) How to check trigger shutter mode. (The command gets a value from address 04)

【Send Command】

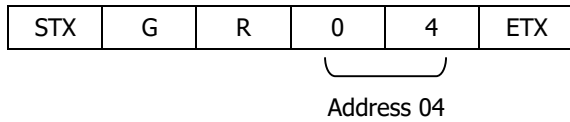

【Return value form camera】

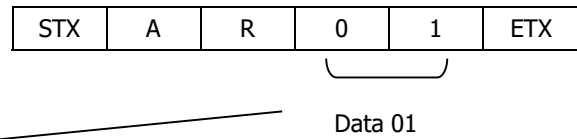

【Receive Return Value】

The camera is working with a trigger shutter mode, because the command received a 01 from the camera.

2) How to check trigger shutter mode. (The command gets consecutive 2 bytes values from address 20)

【Send Command】

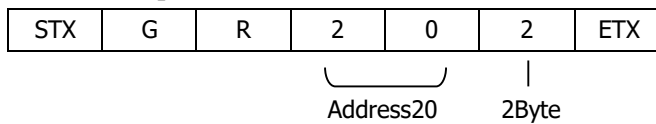

【Receive return value】

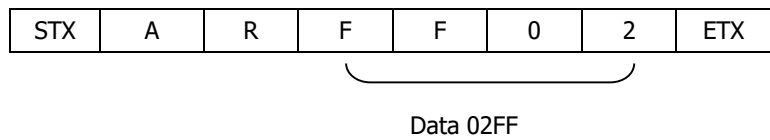

【Receive return value】

The shutter mode of camera is working +12dB, because the command received a 02FF(767) from the camera.

3) How to set partial scan mode. (The command sets 01 for address 08)

【Send Command】

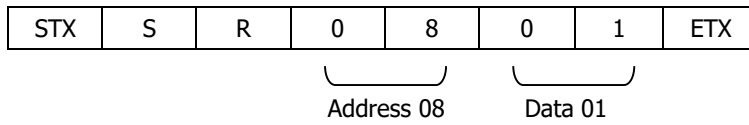

【Return value form camera】

ACK

【Receive Return Value】

The command finished normally, because the command received ACK from the camera.

4) How to set 01FF for manual shutter. (The command set 01FF for address 24)

【Send Command】

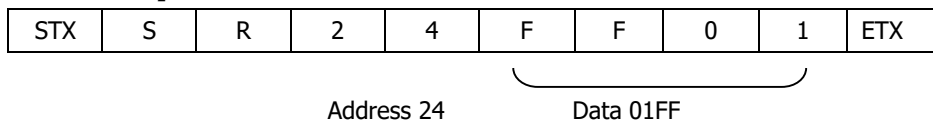

【Return value form camera】

ACK

【Receive Return Value】

The command finished normally, because the command received ACK from the camera.

5) How to save configurations of a camera. (The command send CS)

【Send Command】

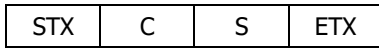

【Return value form camera】



【Receive Return Value】

The command finished normally, because the command received ACK from the camera.

6) How to restore the camera to initial settings. (The command send CR)

【Send Command】

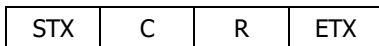

【Return value form camera】



【Receive Return Value】

The command finished normally, because the command received ACK from the camera.

7) How to get detail of a communication error.

【Send Command】

STX	G	R	@	0	ETX
-----	---	---	---	---	-----

Set the address invalid value



【Return value form camera】

NAK



【Receive return value】

The command finished abnormally, because the command received 'NAK' from the camera.

When the command did not finish normally, retry to send command or send to get detail of a detail error command.

【Send Command】

STX	Q	E	ETX
-----	---	---	-----

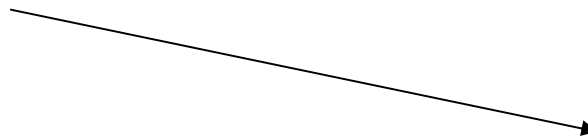

【Return value form camera】

STX	R	E	1	0	2	ETX
-----	---	---	---	---	---	-----

Kind1 Detail 02



【Receive Return Value】

The 'GR' command accessed invalid address , because the error command received kind '1' and detail '02'.

10. Function Setting

Function	Address(Hex)	Data(Hex)	
Preset shutter	01	00:	1/22s(OFF)
		01:	1/30s
		02:	1/45s
		03:	1/60s
		04:	1/90s
		05:	1/120s
		06:	1/180s
		07:	1/350s
		08:	1/700s
		09:	1/1400s
		0A:	1/3000s
		0B:	1/6500s
		0C:	1/13000s
		0D:	1/34000s
		0E:	1/130000s
0F:	Manual shutter (address 24h-25h)		
Trigger shutter mode	04	00:	Normal shutter mode (Trigger OFF)
		01:	Fixed trigger mode (address 01h)
		02:	Pulse width trigger shutter mode
Trigger polarity	05	00:	Positive
		01:	Negative
Trigger input	06	00:	CC1
		01:	12pin connector 11pin in
Partial scan mode	08	00:	Full frame
		01:	Partial scan
Gunma ON/OFF	09	00:	Gunma OFF($\gamma=1.0$)
		01:	Gunma ON($\gamma=0.45$)

Function	Address(Hex)	Data(Hex)	
CL Output Mode	0A	00:	Base Configuration 2Tap
		01:	
Camera Link bit	0B	00:	8bit
		01:	10bit
		02:	12bit
Camera Image bit position setting (Low Gain)	14	00:	B11 : B0
		01:	B10 : B0+'0'
		02:	B9 : B0+'00'
		03:	B8 : B0+'000'
		04:	B7 : B0+'0000'
Flip upside down	18	00:	OFF
		01:	ON
Global Reset Mode	19	00:	OFF
		01:	ON (Trigger Mode :01h or 02h)
LED	1B	00:	OFF
		01:	ON
Sensor Mode	1C	00:	Low Gain
		01:	High Gain
		02:	2-CMS
Image Filter	1F	00:	OFF
		01:	3x3 filter ON (Address : 60h~68h)
		02:	3x3 Median filter ON
		03:	3x3 Median filter ON + 3x3 filter ON
Partial scan : Long exposure mode	1E	00:	OFF
		01:	ON
Manual Gain	20-21	LLHH:	min:0(0H) - max:3840(0F00H) x1.0(0dB)~x16.0(+24dB) Gain = (setting value +256)/256
			0(0000H) : x1.0(0dB)
			256(0100H) : x2.0(+6dB)
			768(0300H) : x4.0(+12dB)
			1792(0700H) : x8.0(+18dB)
3840(0F00H) : x16.0(+24dB)			

Function	Address(Hex)	Data(Hex)								
Manual Shutter	24-25	LLHH:	min:0(0000h) - max:2047(7FFh)							
			Shutter time (Base Configuration 2Tap) = 7.731us + (2047 - (setting value)×21.538us min:0=44.096ms, max:2047=7.731us							
Sensor Board Temperature (Read Only)	2E	LL:	max +150° : 150(96h) 0° : 0(00h) min - 55° : 201(C9h)							
FPGA Board Temperature (Read Only)	2F	LL:	max +150° : 150(96h) 0° : 0(00h) min - 55° : 201(C9h)							
Low Gain CMOS Gain Resister	36	00:	1.0 x	10:	5.0 x	20:	9.0 x	30:	13.0 x	
		02:	1.5 x	12:	5.5 x	22:	9.5 x	32:	13.5 x	
		04:	2.0 x	14:	6.0 x	24:	10.0 x			
		06:	2.5 x	16:	6.5 x	26:	10.5 x			
High Gain CMOS Gain Resister	37	08:	3.0 x	18:	7.0 x	28:	11.0 x			
		0A:	3.5 x	1A:	7.5 x	2A:	11.5 x			
		0C:	4.0 x	1C:	8.0 x	2C:	12.0 x			
		0E:	4.5 x	1E:	8.5 x	2E:	12.5 x			
High Gain : Black level	34-35	LLHH:	min:0(0000h) - max:255(00FFh)							
Low Gain/2-CMS : Black level	38-39		Individual adjustment so that the image output is 02 h digit or less with 8-bit output at the time of shipment from the factory							

Function	Address(Hex)	Data(Hex)	
Partial Scan Start Position	40-41	LLHH:	Full frame scan mode : 0(0000h) min:0(0000h) - max:2046(07FEh)
Partial Scan Effective line number	50-51	LLHH:	Full frame scan mode : 2048(0800h) min:1(0001h) - max:2048(0800h)
3x3 Filter coefficient	60~68	LL:	Please set so that the total sum is '1'. Possible values are 1, 2, 4, 8

※ The data set with 1 Byte

< Example > Trigger Mode (Address 04) ->02(02H)

STX SR 04 2 ETX

※ LLHH : The data set with 2 Byte shall be set with Low Byte first, then set with High Byte.

< Example > Manual Shutter (Address 24-25) ->6671(1A0FH)

STX SR 24 0F 1A ETX

11. Dimensions

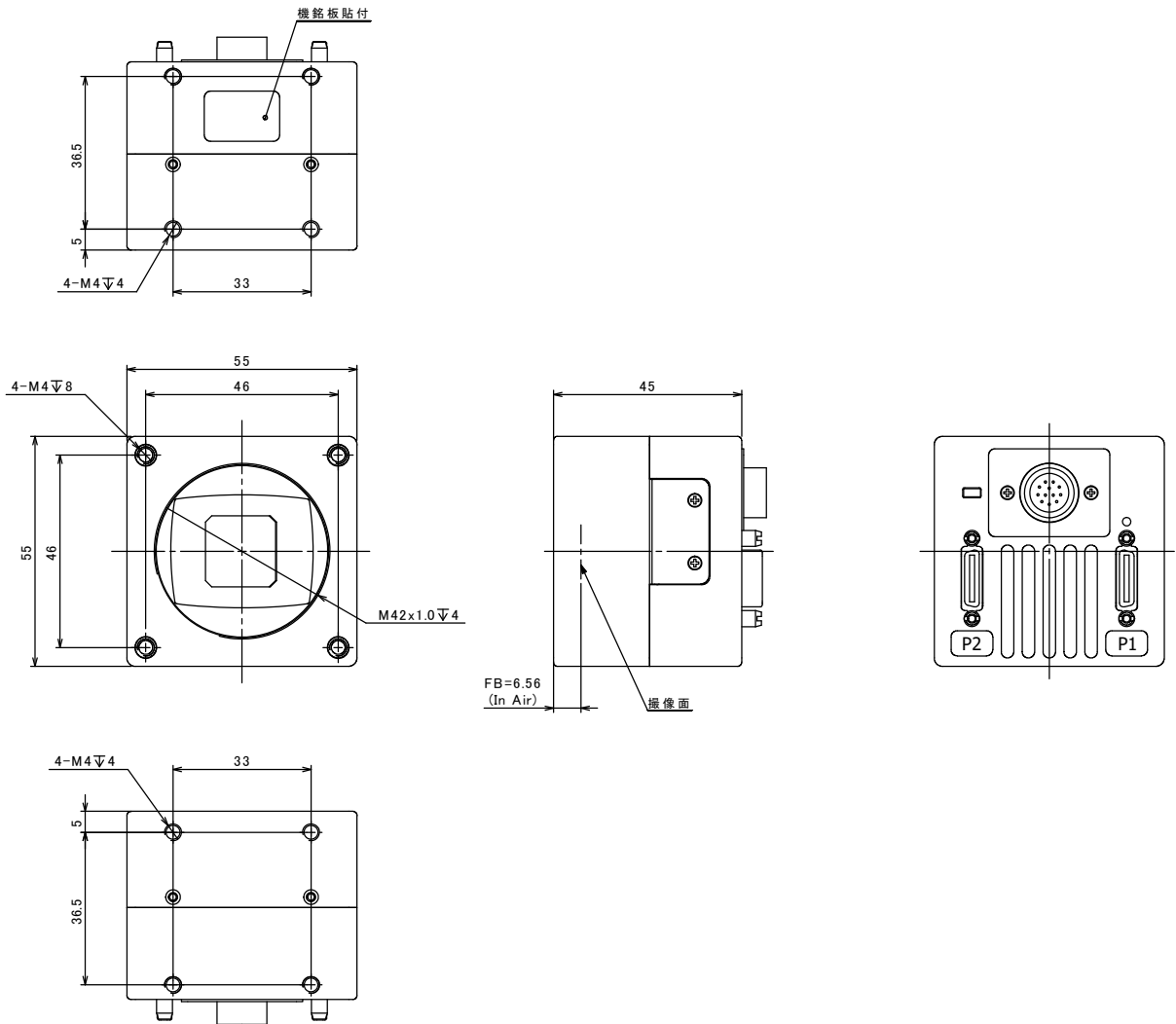

12. Initial Setting

Function	Address(Hex)	Data(Hex)	
Preset-Shutter	01	00:	1/22s(OFF)
Trigger shutter Mode	04	00:	Normal(Trigger OFF)
Trigger polarity	05	00:	Positive
Trigger input	06	00:	CC1
Partial scan Mode	08	00:	Full frame
Gamma	09	00:	OFF($\gamma = 1.0$)
Camera output Mode	0A	00:	Base Configuration 2Tap
Camera Link output	0B	00:	8bit
Camera output bit position	14	00:	12bit data B11:B0 output
Flip	18	00:	OFF
Global Reset Mode	19	00:	OFF
LED ON/OFF	1B	01:	ON
Sensor Mode	1C	00:	Low Gain
Partial scan : Long exposure mode	1E	00:	OFF
Image filter	1F	00:	OFF
Manual Digital Gain	20-21	0000:	X1.0(0dB)
Manual Shutter	24-25	0000:	shutter(OFF)
Low Gain /2-CMS analog gain register	36	02:	1.5 x
High Gain analog gain register	37	26:	10.5 x
Low Gain black level	38-39	Xxxx:	Solid adjustment
High Gain black level	34-35	Xxxx:	Solid adjustment
Partial scan start position	40-41	0000:	Start position
Partial scan effective line number	50-51	0800:	Effective Line number 2048
3x3 Filter coefficient	60	01:	
	61	02:	
	62	01:	
	63	02:	
	64	04:	
	65	02:	
	66	01:	
	67	02:	
68	01:		

13. Cases for Indemnity (Limited Warranty)

We shall be exempted from taking responsibility and held harmless for damage or losses incurred by the user in the following cases.

- In case damage or losses are caused by fire, earthquake, or other acts of God, acts by third party, deliberate or accidental misuse by the user, or use under extreme operating conditions.
- In case indirect, additional, consequential damages (loss of business interests, suspension of business activities) are incurred as result of malfunction or non-function of the equipment, we shall be exempted from responsibility for such damages.
- In case damage or losses are caused by failure to observe the information contained in the instructions in this product specification & operation manual.
- In case damage or losses are caused by use contrary to the instructions in this product specification & operation manual.
- In case damage or losses are caused by malfunction or other problems resulting from use of equipment or software that is not specified.
- In case damage or losses are caused by repair or modification conducted by the customer or any unauthorized third party (such as an unauthorized service representative).

14. CMOS Pixel Defect

IDULE compensates the noticeable CMOS pixel defects found at the shipping inspection prior to our shipment. On very rare occasions, however, CMOS pixel defects might be noted with time of usage of the products.

Cause of the CMOS pixel defects is the characteristic phenomenon of CMOS itself and IDULE is exempted from taking any responsibilities for them. Should you have any questions on CMOS pixel defects compensation, please contact us.

15. Product Support

When defects or malfunction of our products occur, and if you would like us to investigate on the cause and repair, please contact your distributors you purchased from to consult and coordinate.
